

IN-STOCK

Mailbox Locks

FOR INTERIOR ARCHITECTURAL MAILBOXES



MBL82010 Features:

- *Used in apartments, condominiums, schools, lobbies*
- *Nut or clip mounted*
- *90° counter-clock-wise cam turn to open.*
- *Key removable in locked position only.*
- *Supplied with selection of five cams, two keys, mounting nut, mounting clip, lock washer and cam screw.*

Stock ID 82010 • 25 to box



Security Products A Division of The Eastern Company

301 West Hintz Road | Wheeling, IL 60090 | Telephone: 800.733.8588 | Fax: 847.537.1881
www.cclsecurity.com

A Proud Union Company. (S.E.I.U.)

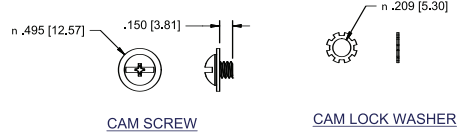
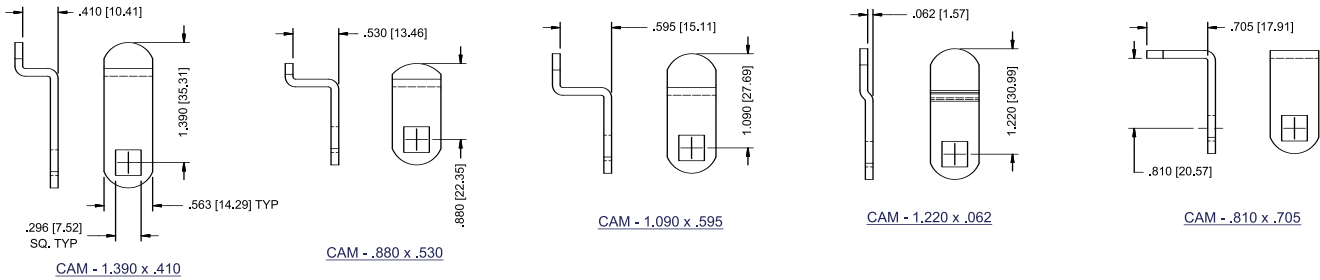
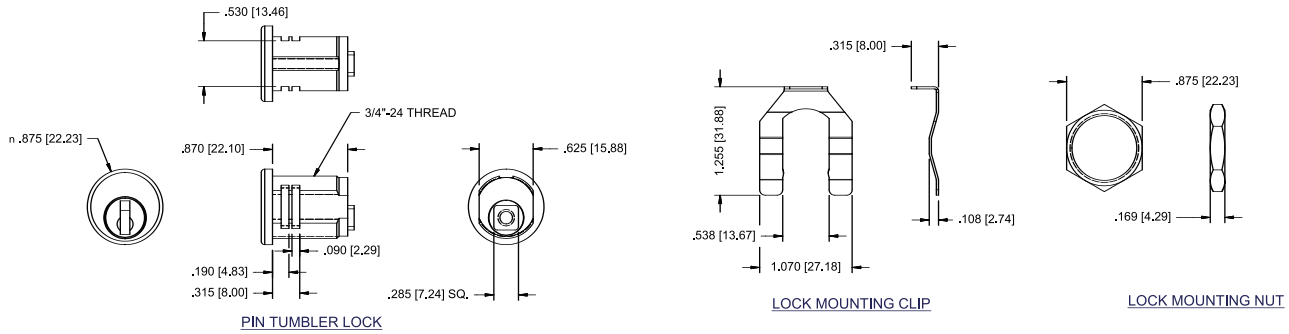

NOTES:
 1. LOCK, KEYS, AND ALL HARDWARE PACKED TOGETHER IN PRINTED AND SEALED POLY BAG (SEE ARTWORK FOR BAG PRINTING).
 2. LOCK KIT SUPPLIED WITH 2 KEYS, CCL LOGO STAMPED ON HEAD.
 3. LOCKS KEYED DIFFERENT TO xxx COMBINATIONS.

MBL82010 MAILBOX LOCK

Contents:

Lock cylinder with two keys, multi-cam assortment, mounting clip and nut, cam screw with lockwasher.

Description:

Diecast cylinder with nickel plated face; brass pins; spring steel locking clip; replaces many manufacturers' original equipment product; these multi-cam assortments can eliminate stocking of individual locks; all cylinders rotate 90° counter clockwise to open.

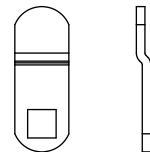

Bommer

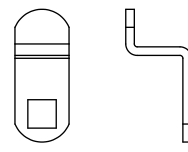

Auth Electric

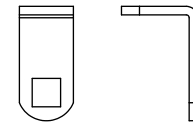

Miami-Carey

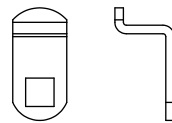

Florence

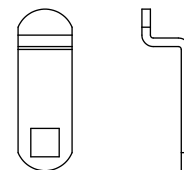

American



Cam Screw



Lock Washer

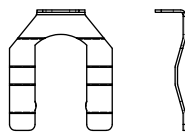

Mounting Clip

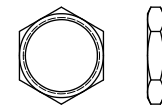

Mounting Nut